

	PROJECT			
	<b>Mitred End Table With Inset Top</b>			
	TITLE			
	<b>Mitred End Table With Inset Top</b>			
APPROVED	SIZE	CODE	DWG NO	REV
CHECKED	A			
DRAWN JT	2021-02-10	SCALE 1:10	WEIGHT	SHEET 1/5

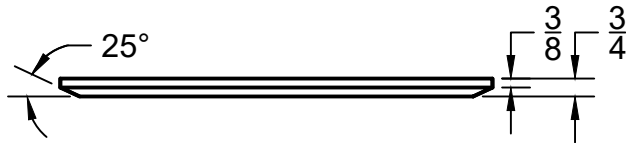

	PROJECT			
	Mitred End Table With Inset Top			
	TITLE			
	Top			
APPROVED	SIZE	CODE	DWG NO	REV
CHECKED	A			
DRAWN J T	2021-02-10	SCALE 1:16	WEIGHT	SHEET 2/5

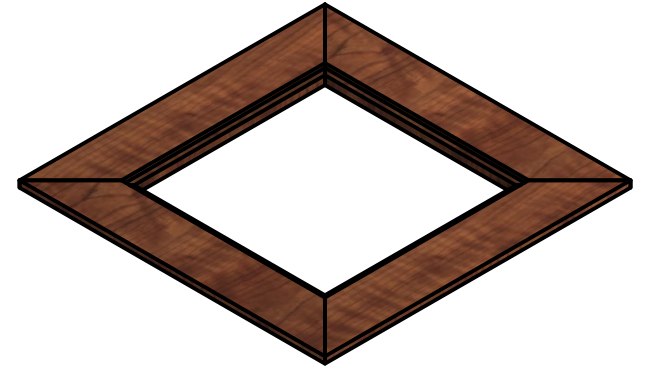

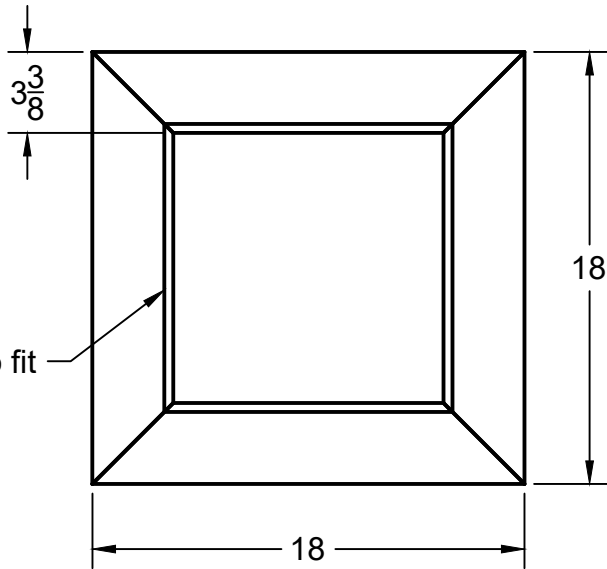
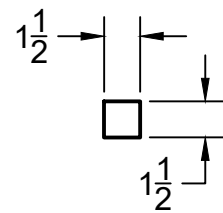
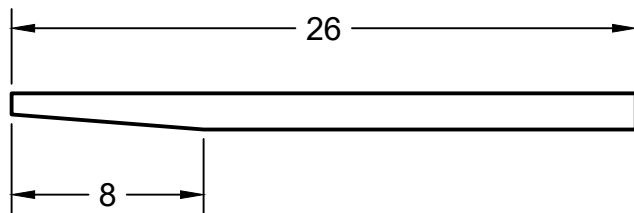
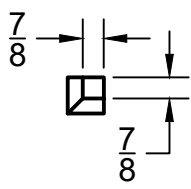
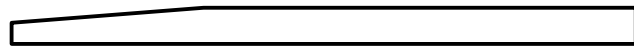
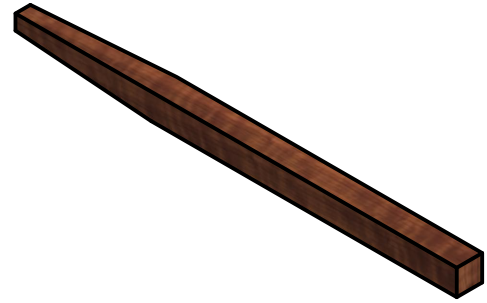

	PROJECT			
	Mitred End Table With Inset Top			
	TITLE			
	Tapered Table Leg (4 required)			
APPROVED	SIZE	CODE	DWG NO	REV
CHECKED	A			
DRAWN JT	2021-02-10	SCALE 1:8	WEIGHT	SHEET 3/5



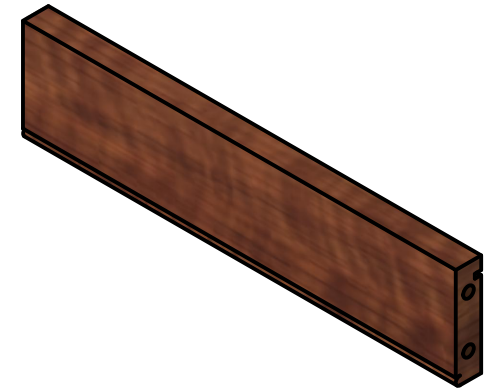
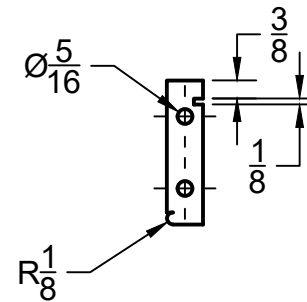
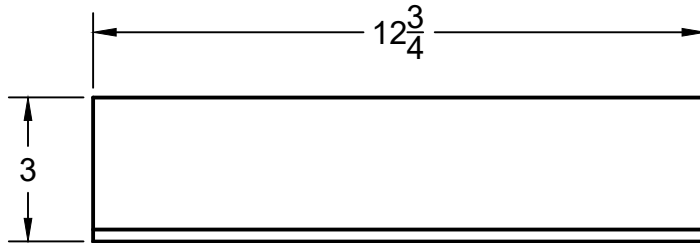
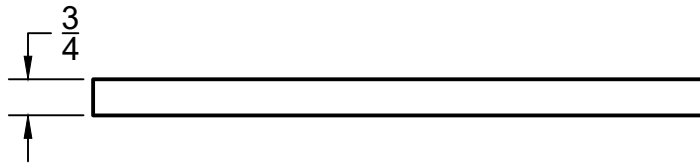

		PROJECT		
		Mitred End Table With Inset Top		
		TITLE		
		Table Apron (4 required)		
APPROVED	SIZE	CODE	DWG NO	REV
CHECKED	A			
DRAWN J T	2021-02-10	SCALE 1:8	WEIGHT	SHEET 4/5

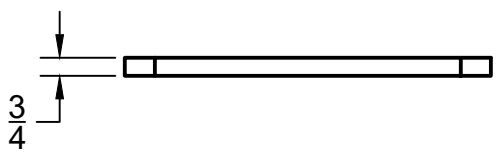
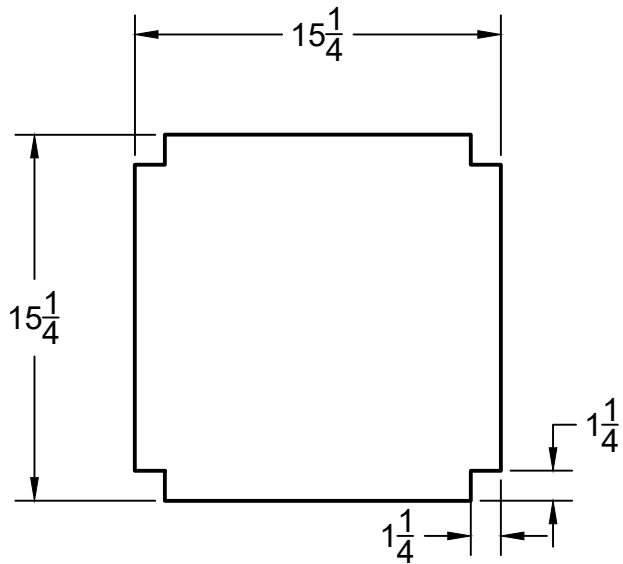

	PROJECT		
	<b>Mitred End Table With Inset Top</b>		
	TITLE		
	<b>Shelf (optional)</b>		
APPROVED	SIZE	CODE	DWG NO
CHECKED	A		
DRAWN J T	2021-02-10	SCALE 1:8	WEIGHT
			SHEET 5/5