

Home Electrical Wiring

Getting the electricity from the main power lines to a location in the house

90% of BC power comes from Hydro



There is potential energy stored in a water reservoir behind a dam. It is converted to kinetic energy when the water starts flowing down the penstock, from the dam. This kinetic energy is used to turn a turbine. Water is a renewable resource, unlike diesel, natural gas or coal.

Inside a Hydropower Plant

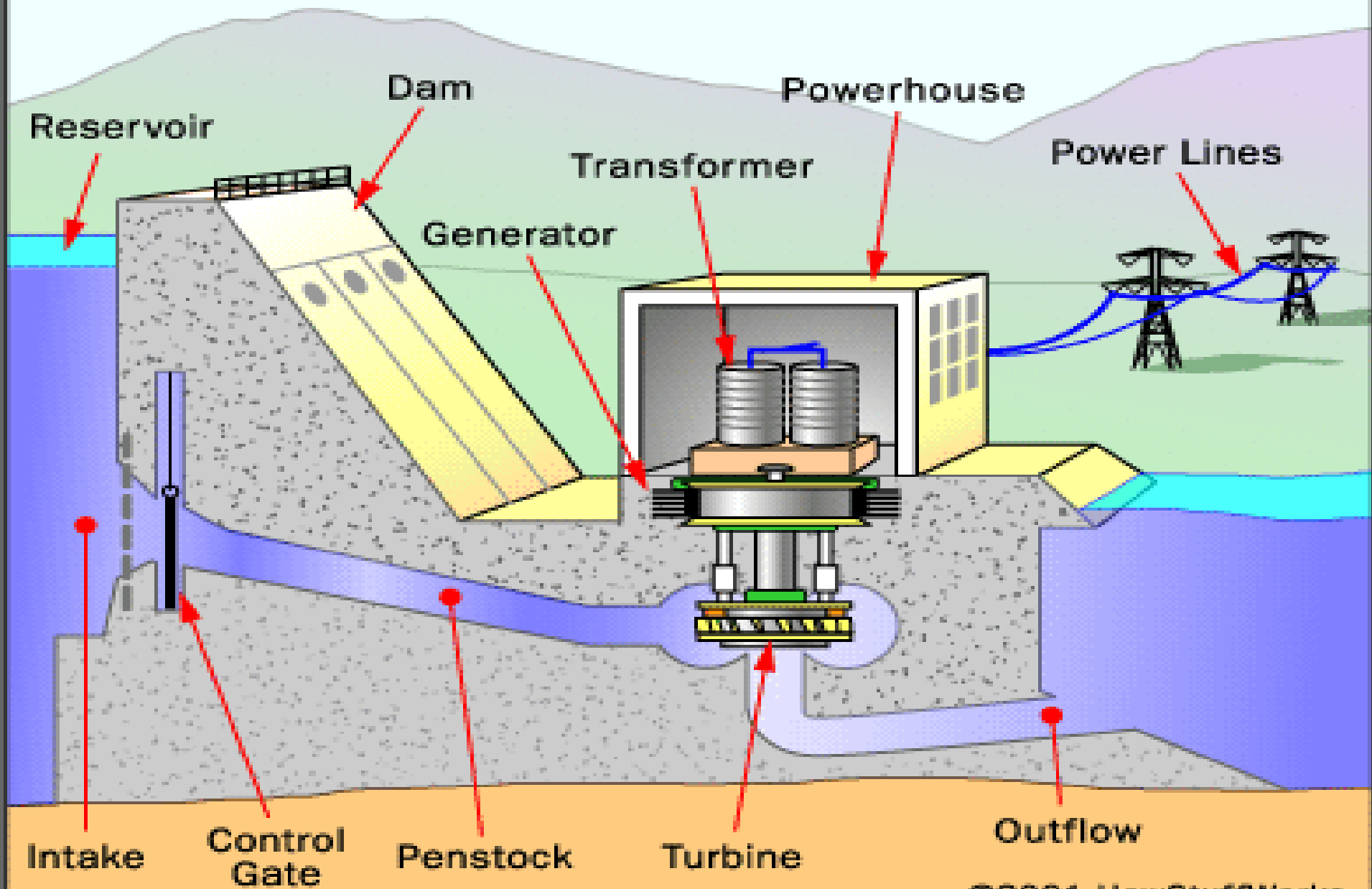

DAM

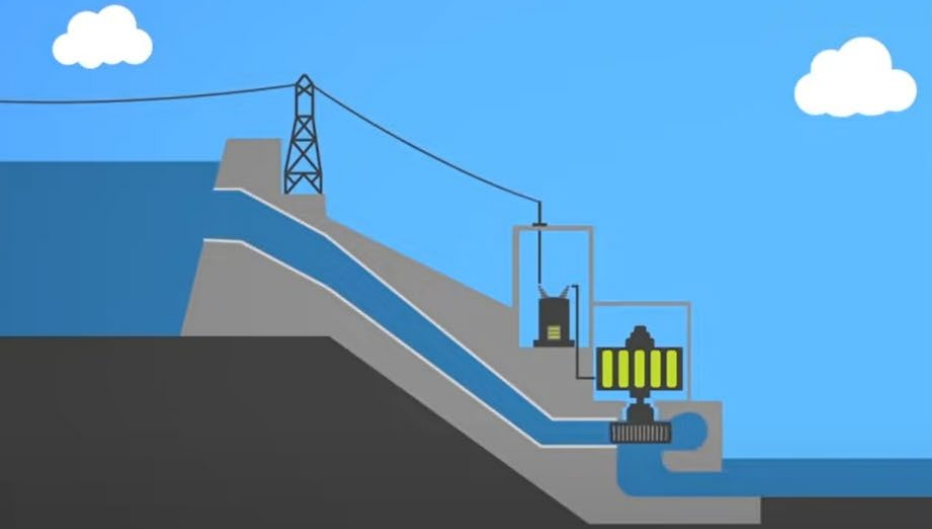

RUN OF RIVER

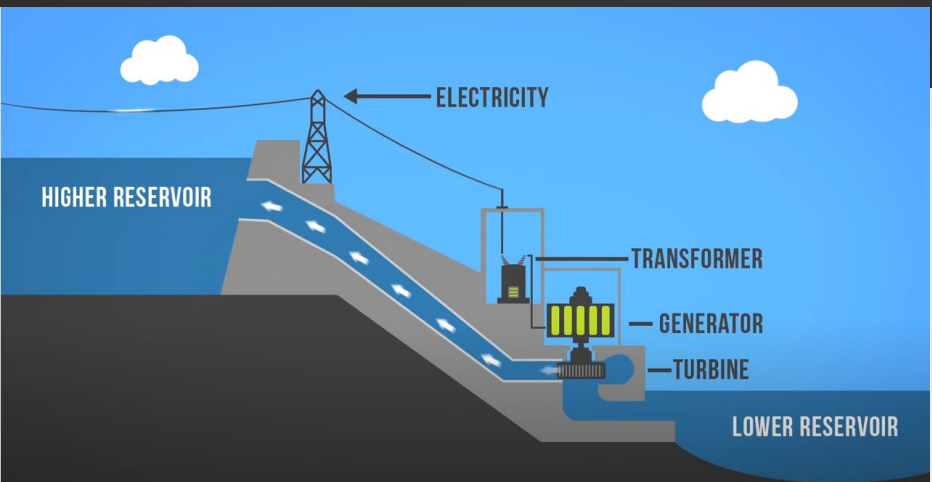
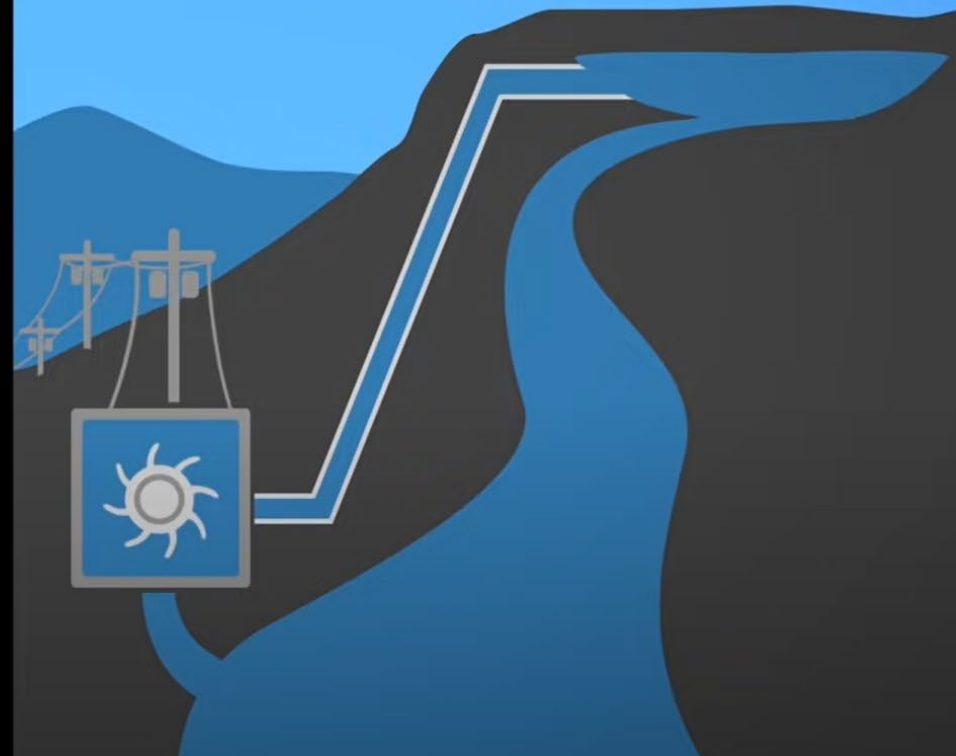

Generators

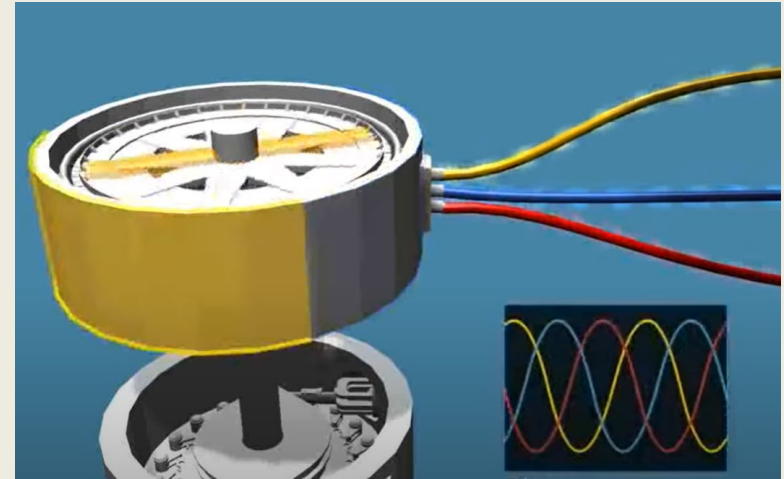

Falling water strikes a series of blades attached to a shaft which converts the kinetic energy to mechanical energy causing a turbine to rotate. The shaft is attached to a generator, which produces 3 phase electricity.

Step-Up Transformers

Generators produce a low alternating current (AC) voltage. In order for the transmission lines to carry the electricity efficiently over long distances, this low AC generator voltage is increased to a higher transmission voltage by a step-up transformer.

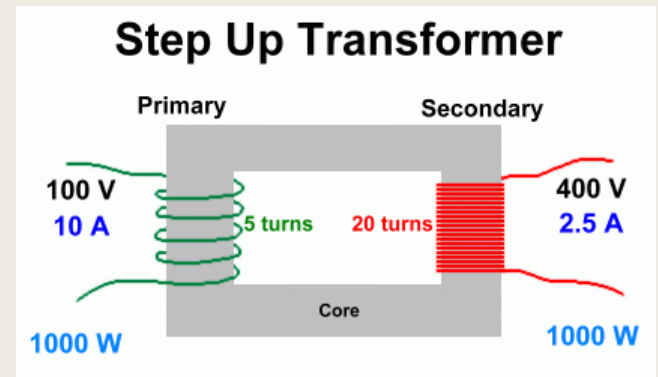

High Voltage Transmission lines

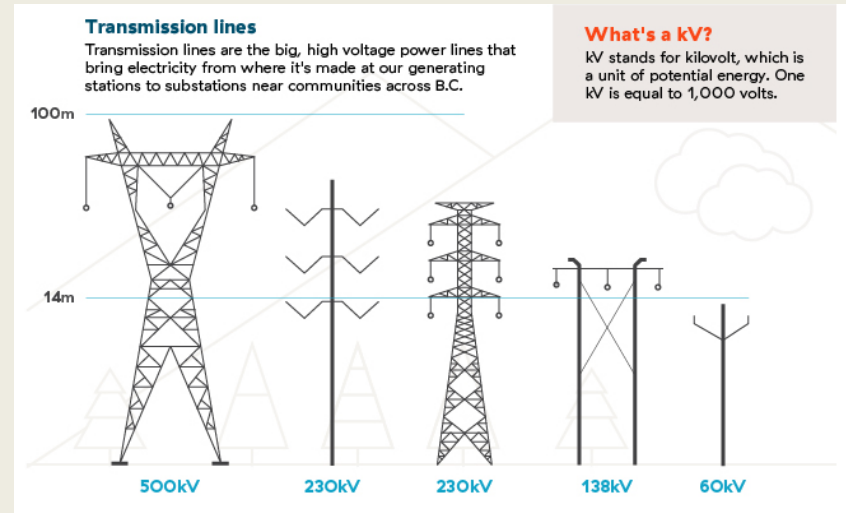

Grid transmission lines, usually supported by tall metal towers, carry high voltage electricity over long distances. The BC Hydro high-voltage transmission system consists of more than 18,286 kilometres of transmission lines, operating at voltages from 60 kV to 500 kV.

Distribution Substations



A distribution substation is a system of transformers, meters, and control and protective devices. At a substation, transmission line voltage is reduced to lower voltages for distribution to residential, commercial, and small and medium industrial customers.

Distribution Lines

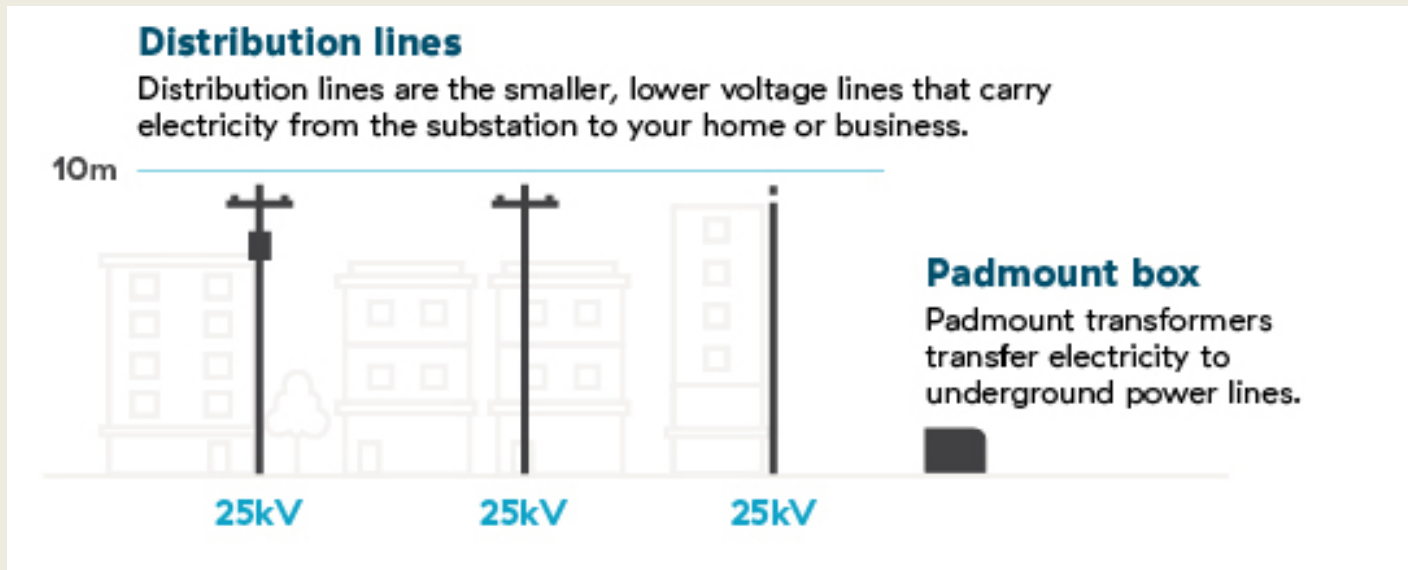

- BC Hydro has approximately 55,254 kilometres worth of distribution lines (7200 volts) carrying the electricity to customers. These lines are either above ground or underground.

Transformers

- When electricity is ready to be delivered to your home transformers are needed to lower the voltage down to a more usable level (120/240v).
- Depending on where you live, you either have a transformer mounted on the ground because the wires are below ground (in newer subdivisions) or on a power pole in the case of above ground wires (rural or in older subdivisions).



How many wires go from the transformer to your house?

- Once the voltage is lowered by the transformer the power company runs 3 wires to your home. Two “hot” wires carrying 120 volts and a Neutral Wire (CT in the example).

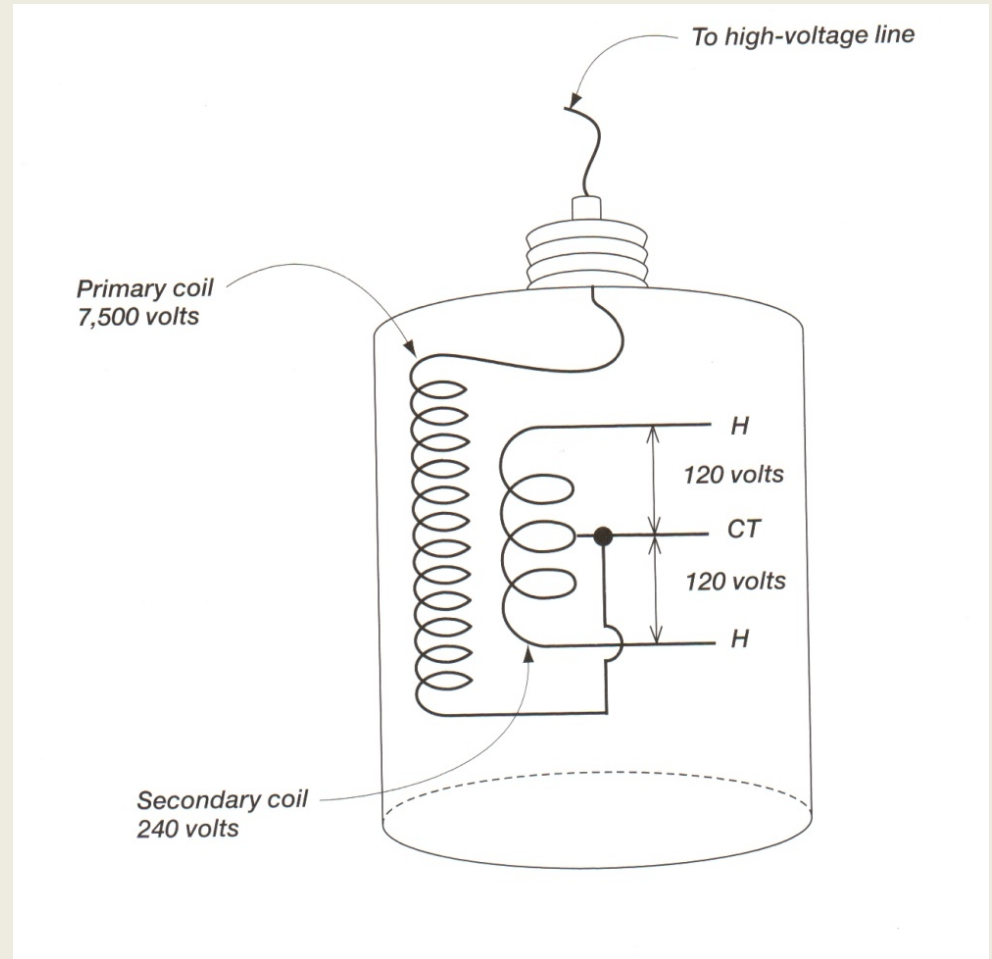

Living in a Rural Area

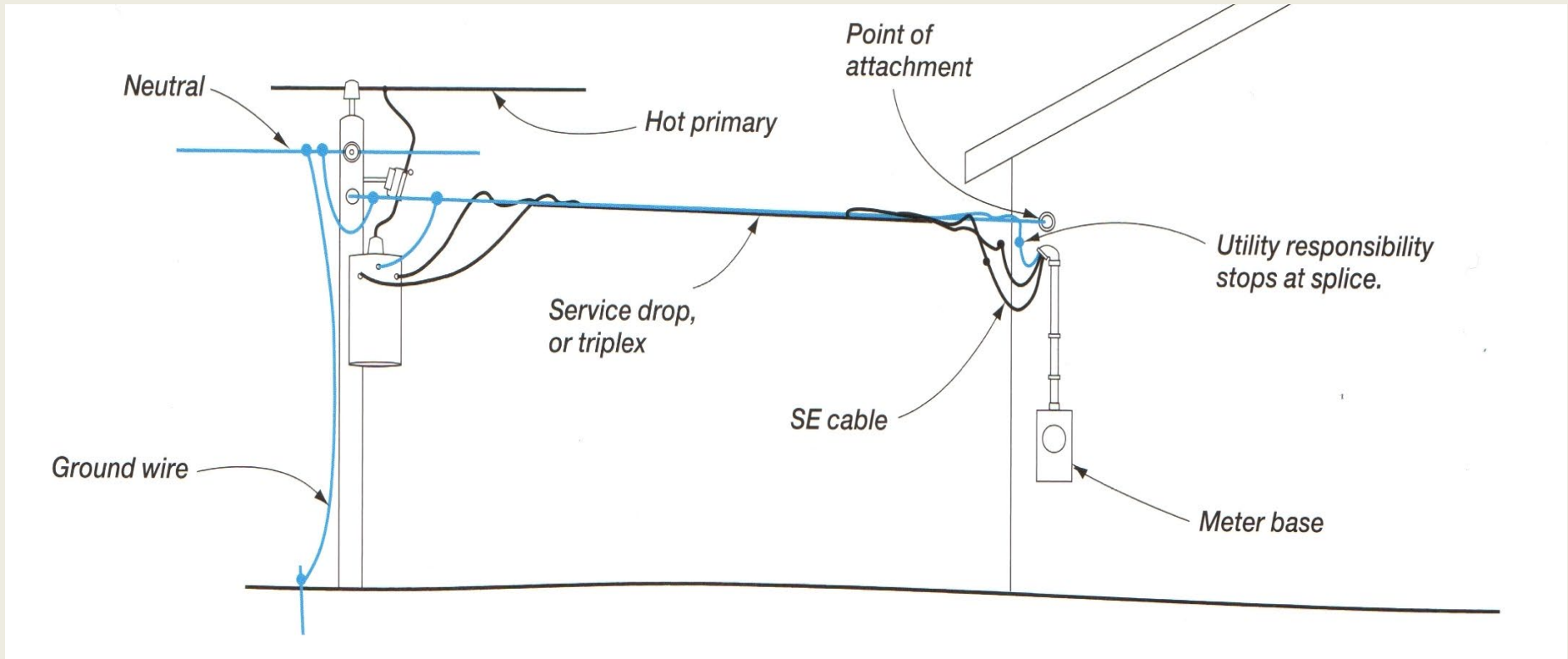

Notice the “Ground wire” attaching to the neutral wire at the power pole and then into the ground. This is to prevent electrocution.

Living in a subdivision

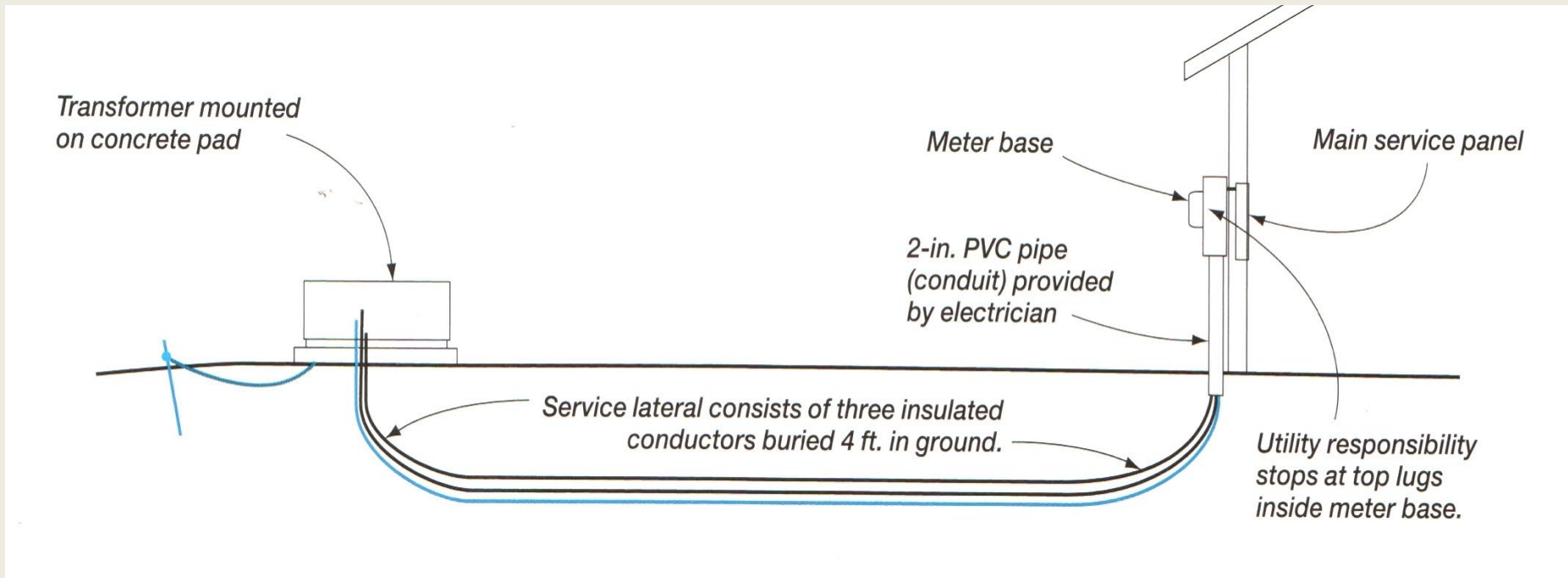

Notice the Ground wire in the ground by the transformer

The Meter Box

- The first thing the wires from the Power Company attach to is the meter box.
- In the example, the 3 wires entering from the top are coming from the Power Company. The middle (taped white) is the Neutral and the outside 2 are the “Hot”. Remember, each “Hot” wire is carrying 120 volts.
- At the bottom the 3 wires enter into the house and will go to the service panel (Breaker Panel)

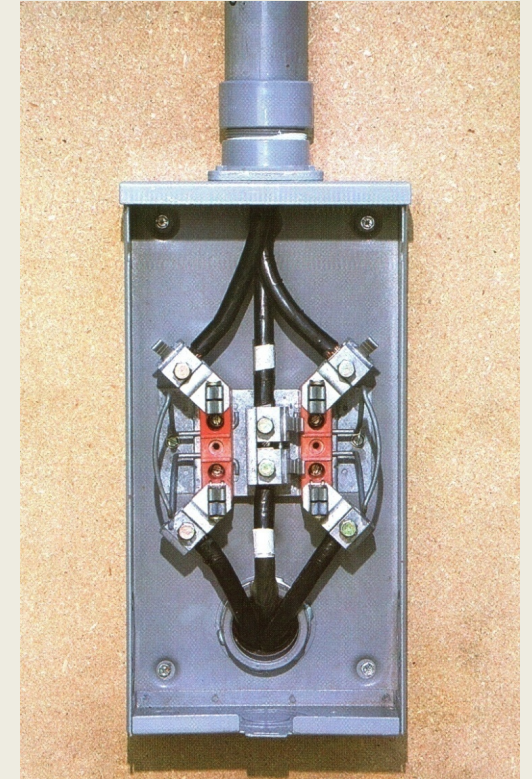

Main Breaker Panel

The 3 wires enter the breaker panel. The “hot” wires go directly to the main breaker which allows you to disconnect the entire power supply to the house. The neutral goes to the neutral/grounding bus. If you exceed your power consumption in the house, the main breaker will “trip”.

After the main breaker are the 2 “Hot” buses.

Circuit breakers are connected between the “hot” bus and the “neutral” bus.

The voltage between the “hot” bus and the “neutral” is 120v. The voltage between the two “hot” buses is 240v.

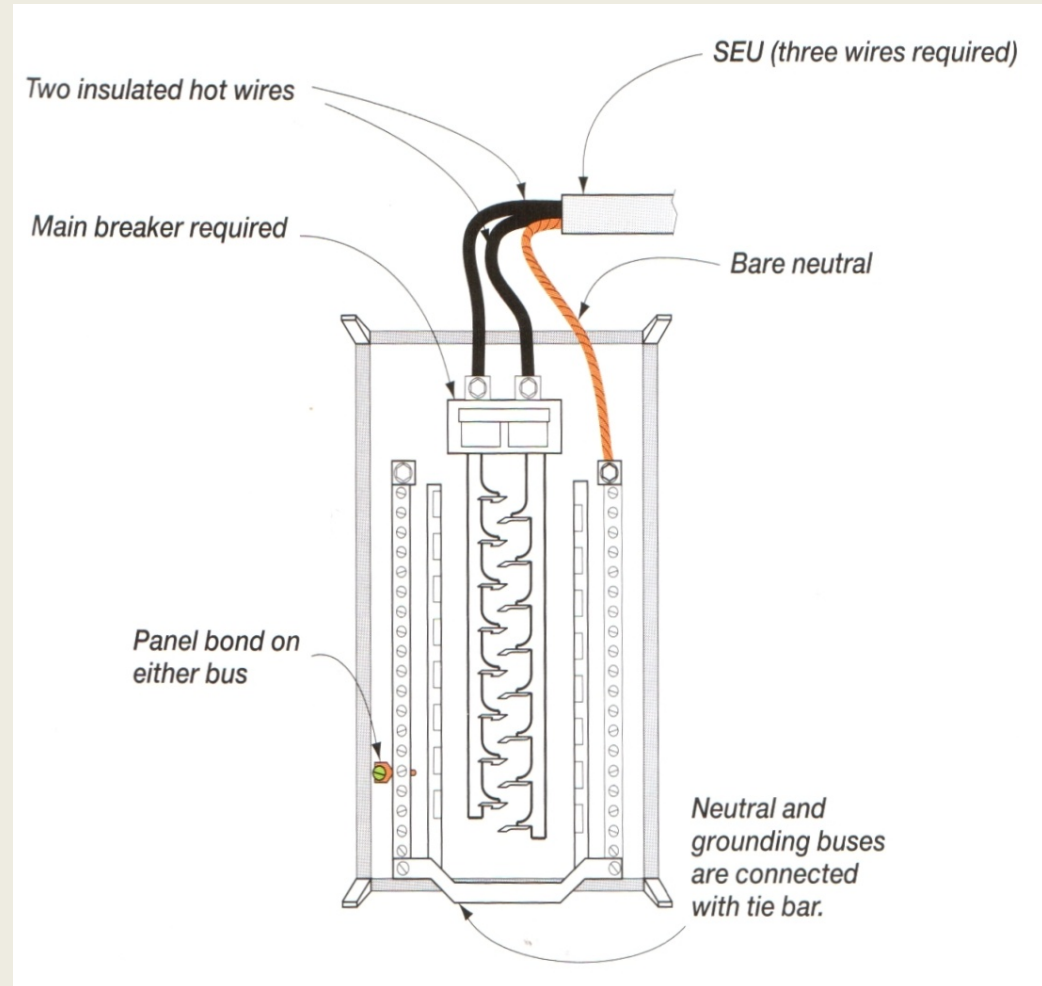

120v on a breaker panel

(returning to the transformer)

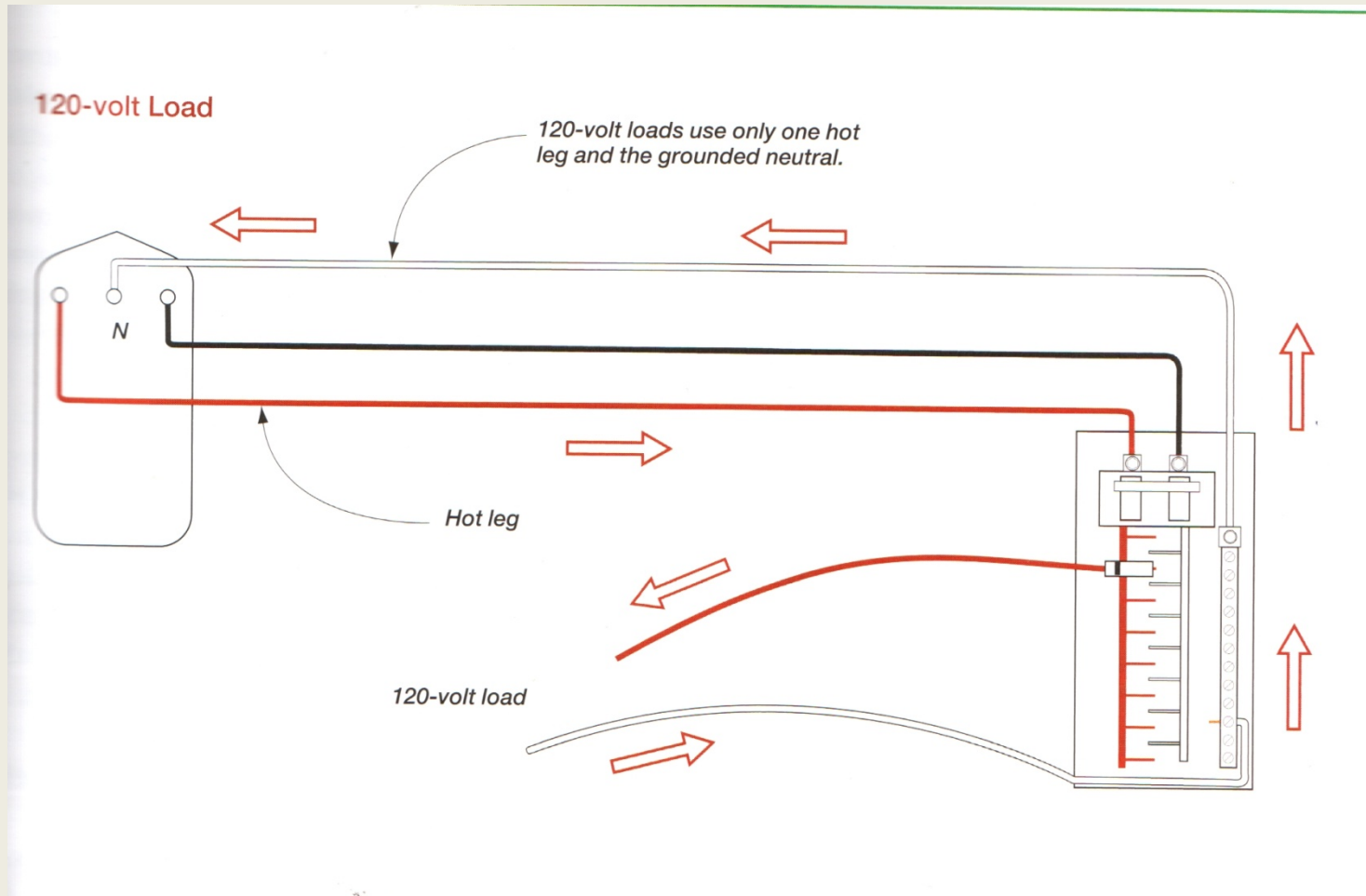

240v on a breaker panel

(returning to the transformer)

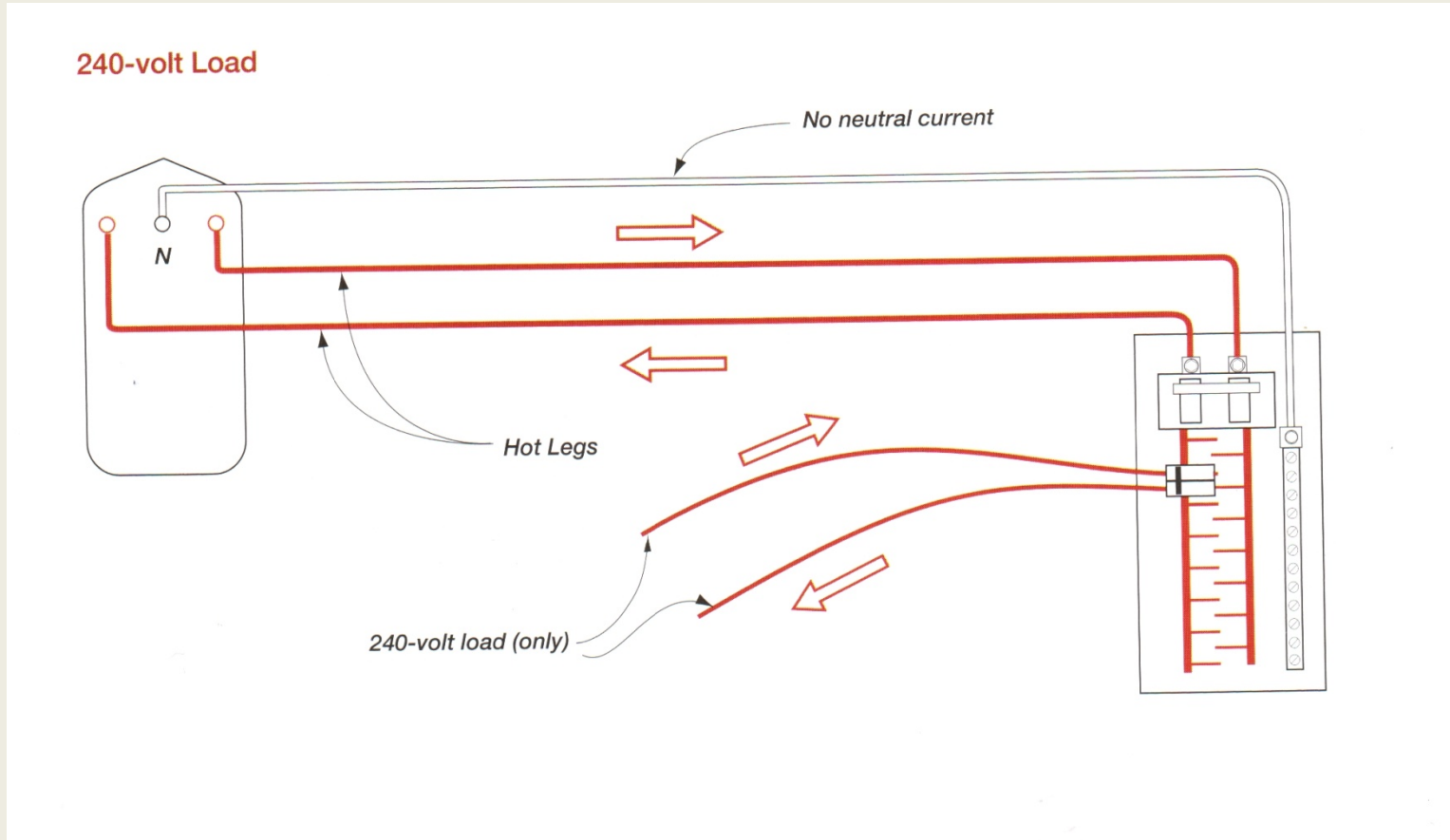

Main Breaker Panel

With Circuit Breakers Installed

- Notice the 3 main wires coming in from the top. The two “Hot” wires and the Neutral.
- A good electrician will wire a panel very neatly for ease of understanding.
- Once the circuit breakers are installed, you are ready to run wires from the panel into your home.

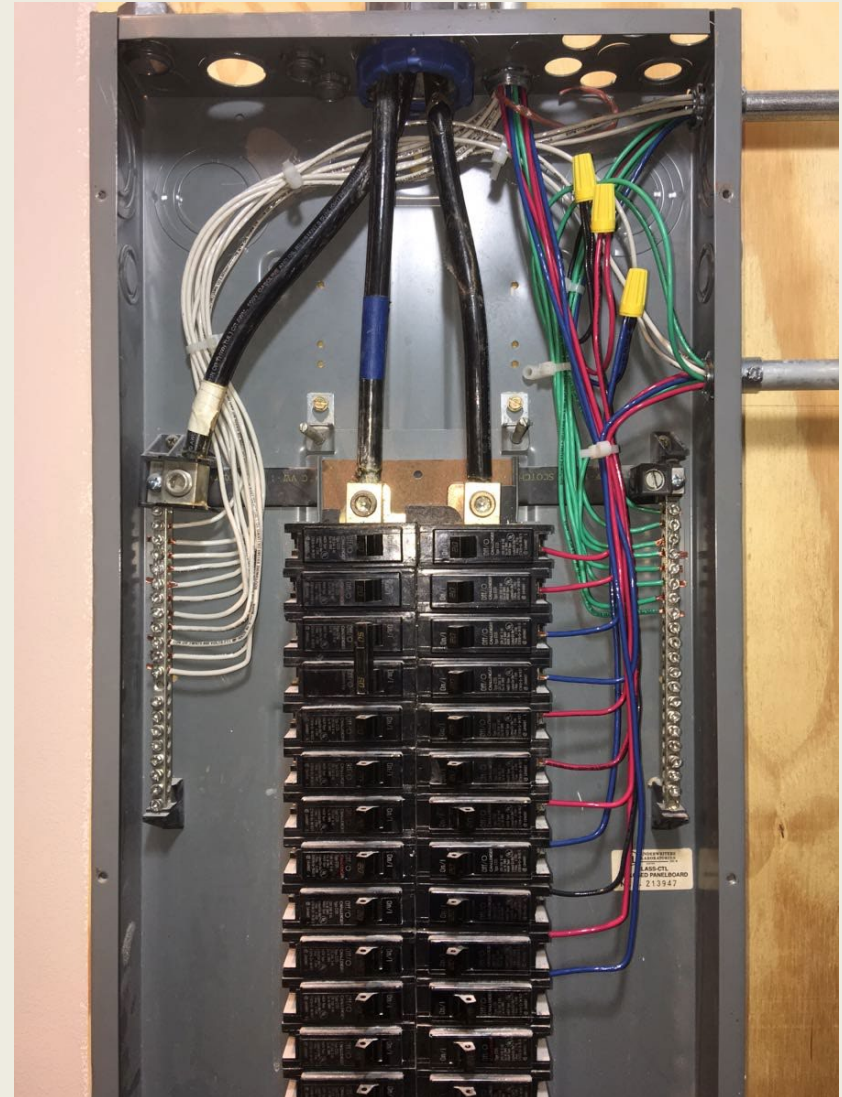

Connecting wires in the Breaker Panel For 120v supplies

- 3 wires always lead away from the breaker panel when you distribute 120v into your house. The “hot” wire (black/red), “neutral” wire (white) and the “ground” wire (bare copper).
- The “hot” wire connects to the circuit breaker, the “neutral” to the neutral/grounding bus and the “ground” wire which also connects to the neutral/grounding bus.
- It is extremely IMPORTANT to have a ground wire as it prevents you from getting electrocuted.

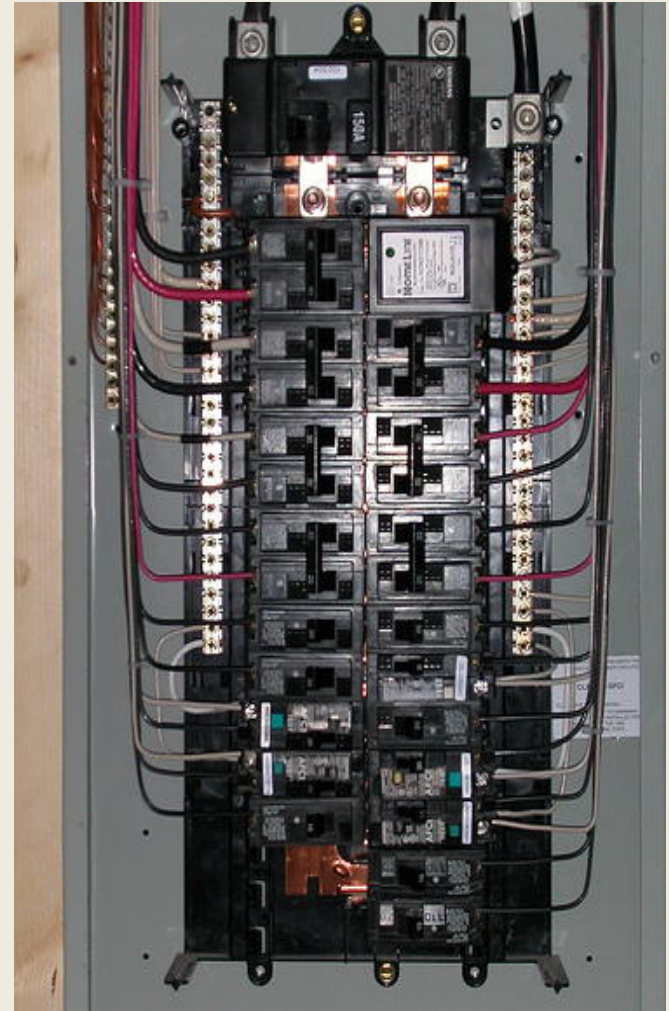

Where the wires go after leaving the breaker panel

- The 3 wires (hot, neutral, ground) leave the breaker panel and run through the walls of your house.
- Holes are drilled through the centre of the studs for the wire to pass through or the wire is stapled to the center of the studs.
- The wire protrudes out of a box between 6 – 8 inches. This is enough to work with.

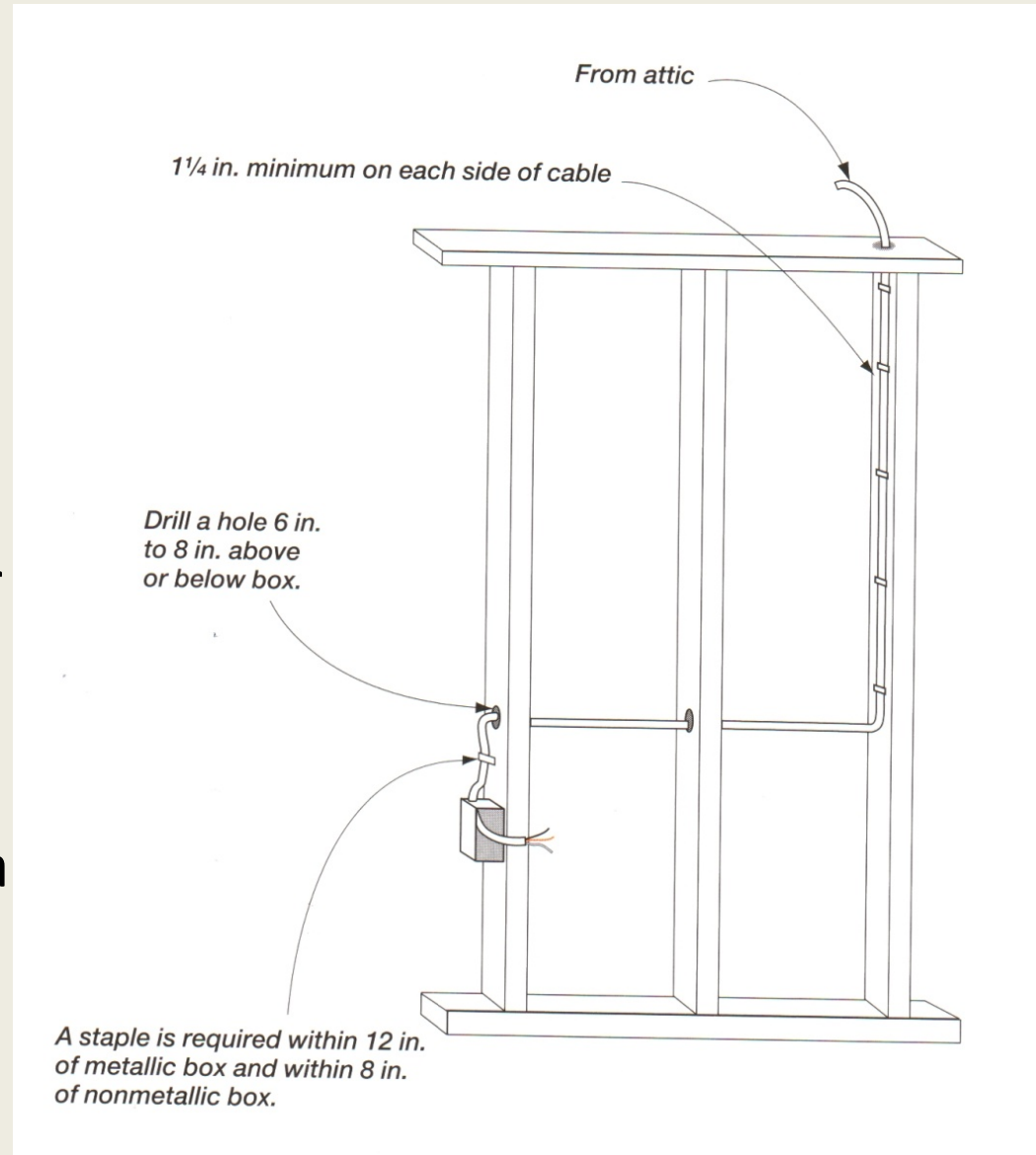

Installing Receptacle and Switch boxes in Walls

- Before the wire exits from the wall or ceiling a switch box, receptacle box or a light fixture box needs to be installed.
- The box must be set forward of the stud by the thickness of the drywall.

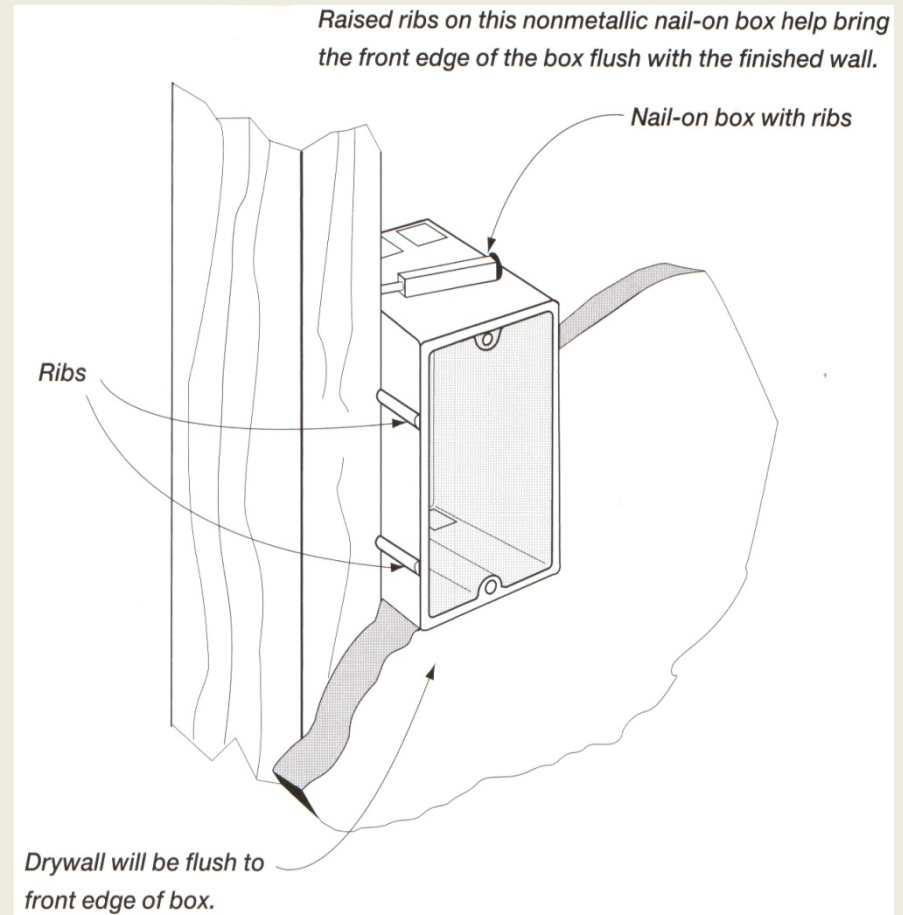

Types of Electrical Device Boxes

- Metal vs Nonmetallic, that is the question.
- Nonmetallic is cheaper, non conductive, faster to install. Hit them too hard and they can crack or damage.
- Metal are stronger, can be added to, more designs.
- Regardless of type, they need to be grounded. There will be a screw located on the inside that the ground wire **MUST** always be attached to.

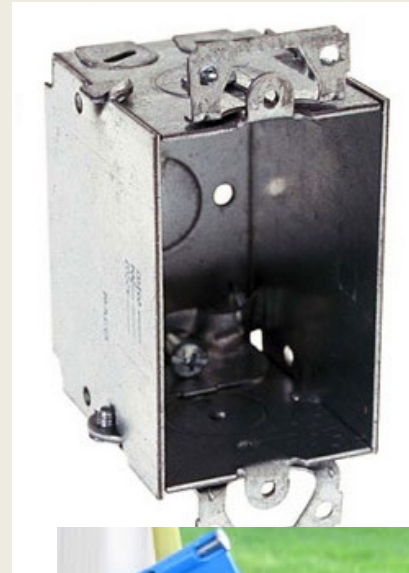

Understanding the wires

- You have 3 wires in a home electrical system;
 - Hot (Black wire) - dangerous one
 - Neutral (White wire)
 - Ground (bare copper or green wire).
- To make things work you need to have the **hot wire** and the **neutral wire** connected to the appliance (load).
- The neutral wire and the ground wire are actually one in the same. If you trace back to the breaker panel you will find that the two are connected together.
- The ground wire is used as a safety on loads where the enclosure is made of metal and the potential for electrical shock is present. If the hot wire shorts out some how, the ground wire which is attached to the metal will prevent you from getting electrocuted as electricity takes the path of least resistance.



Wiring Size for Standard Circuits

(Bedroom, bathrooms, living room, etc)

- 14 gauge wire is the standard for 15amp circuits and 12 gauge is the standard for 20amp circuits.
- Wiring comes packaged in different sizes and number of conductors. The most common in a house are;

- 14/2 (black, white, bare)



- 14/3 (black, white, red, bare)



Start Lab 1